

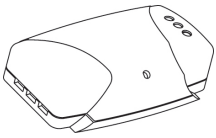

GLASS BREAK DETECTOR

«STEKLO-3M»



Installation Guide

Introduction

Glass break detector «Steklo-3M» (hereinafter, the Detector):

- is intended for detecting destruction of all known kinds of construction glass: common, quenched, patterned, armored, multilayer and laminated with polymer film, glass units, as well as hollow glass blocks installed in structural units (openings) and/or interior elements of closed spaces;
- generates alarm messages by control relay contacts opening and sends it to control panel (hereinafter, the CP);
- ensures case tamper protection by «Failure» relay contacts opening;
- may be installed on the wall, pier between windows and or ceiling.

Features

The Detector:

- ensures remote monitoring of controlled glazed structures of any configuration in a closed area;
- provides monitoring of different types of glasses with different dimensions;
- assures multilevel microprocessor signal processing, functional self-testing and regular monitoring of acoustic channel;
- offers to user an opportunity to choose an algorithm of the Detector operation in accordance with situation on the secured object or with chosen security tactics;
- displays modes of operation of the detector and noises inside the protected closed area by means of LED indication (providing possibility of noise and alarm indication disabling);
- operates in temperature range from minus 20 up to + 45 °C, DC power supply range 9 ... 17 V.

Scope of Delivery

Each Detector unit package contains the items listed in tn Table 1. Table 1

Name	QNT
Glass break detector «Steklo-3M»	1 pc.
Testing ball	*
Screw 3-3x30.016	2 pcs.
Glass break detector «Steklo-3M». Installation Guide	1 copy

* – Supplied optionally

Field of Application

The Detector can be applied in offices, shops, museums, exhibition halls, banks, accommodation rooms, etc.

Choosing Place of Installation

Before installing the Detector, get acquainted with the following requirements:

- when choosing the place of installation, the Detector detection zone location must be taken into account (Figure 1);
- it is recommended to install the Detector at a height not less than 2 m (see examples of installation in Figures 4 – 8);
- during joint operation with an active ultrasonic Detector, distance between Detectors must be not less than 1 m;
- entire area of protected glass should be available to the Detector visibility zone;
- distance (L) from the detector to the farthest point of protected area should not exceed 6 m. If protected glass area is more than 1 m², the specified distance L should be lengthened up to 9 m.
- for protection of quenched, laminated, armored, multilayer or small-area glasses, universal operation mode (See Table 2) should be chosen.

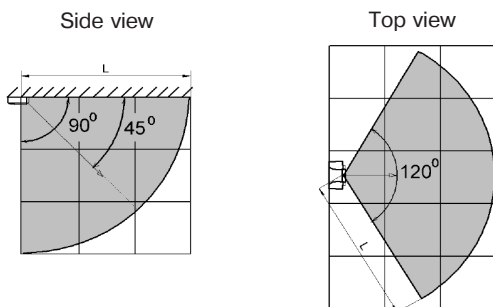

Figure 1 – GB channel detection pattern

Table 2

DIP-switch position						Detector Operating Mode	
1	2	3	4	5	6		
OFF OFF ON ON	OFF ON OFF ON					Sensitivity (detection range) adjustment	minimum +6 dB +14 dB +20 dB (maximum)
		OFF ON				Universal mode Detection of glass destruction with chip fallout	
			OFF ON			Alarm memory indication	– OFF – ON
				OFF ON		LED indication control	– OFF – ON
					OFF ON	Standby mode Adjustment	– LED indicator lighting green

Installation

Choose the Detector place of installation, mark out places for fastening. Remove cover and fasten the Detector by screws.

The Detector Connection

Fulfill the Detector connection in accordance with Figures 2 or 3.

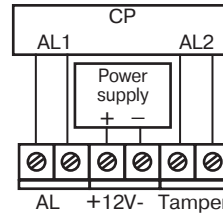

Figure 2 – The Detector connection pattern with separate alarm and case tamper loops

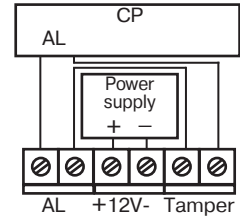

Figure 3 – Detector connection pattern of combined alarm and case tamper loops

Adjustment and Testing

Set DIP-switches «1», «2» and «5» in ON position. Energize the Detector, whereupon the red LED indicator («Alarm» message indication) should light during 2 – 10 sec and go out, displaying that the Detector is turned to the standby mode.

Estimate interference conditions inside protected area. Yellow LED indicator lighting is an evidence of high-frequency noises presence, green LED lighting – of low-frequency ones. If it is possible, eliminate source of noises.

Fulfill the Detector adjustment as follows:

- set DIP-switches «1» and «2» in OFF position, «6» in ON position, «3» and «4» in OFF position;
- suspend a steel ball 20 – 22 mm in diameter on a 30 ... 35 cm long thread, press free end of it to the upper side of a glass structure (ordinary, ornamental, armored, laminated), deflect it at an angle of 30 – 70° (see Table 3, for hollow glass blocks – 45°). Deliver a blow, whereupon the Detector should generate an alarm message. If there is no red LED lighting after test blows (relay contact are not opening), the Detector sensitivity should be increased by DIP-switches «1» and «2» (see Table 2);

Table 3

Glass thickness, mm	<3	3...4	4...5	5...6	6...7	>7
Ball deflection angle for ordinary, armed and ornamental glass, °	30	35	40	45	50	55
Ball deflection angle for, hardened and laminated glass, °	45	50	55	60	65	70

- for the Detector adjustment for multilayer glass or small area of glass protection, it is allowed to use electronic glass break simulator during adjustment;

- check the correctness of the Detector adjustment with the Detector cover installed;

- after completing the Detector adjustment, set DIP-switch «6» to OFF position and choose the mode of operation by «3», «4» and «5» DIP-switches (see Table 2) in accordance with type of secured glass and security tactics accepted for the object.

Manufacturer's Guarantees

The manufacturer guarantees conformity of the Detector to the Technical Specifications requirements provided the transportation, storage, installation and operation conditions are observed.

The guaranteed shelf life of the Detector is 63 months since the date of manufacture.

The guaranteed useful life is 60 months since the day of putting into operation within the guaranteed shelf life.

The Detectors that are found non-conforming to the Technical Specifications requirements shall be repaired by manufacturer, provided the installation and operation rules have been complied with.

Acceptance and Packing Certificate

Glass break detector «Steklo-3M»,

lot number _____ ,

has been manufactured in compliance with the active technical documentation, classified as fit for operation and packed by «RIELTA» JSC.

Person in charge of acceptance and packing

QC representative _____ month, year

Examples of the Detector Installation

Figures 4 – 8 illustrate correct variants of the Detector installation, Figure 9 displays the wrong ones.

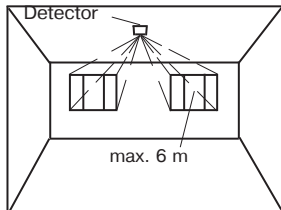

Figure 4 – Installing the Detector on the Ceiling

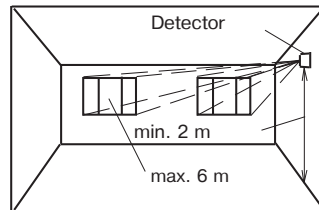

Figure 5 – Installing the Detector on a Side Wall

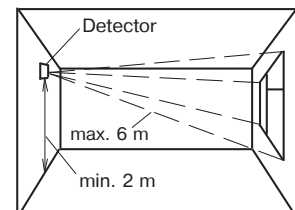

Figure 6 – Installing the Detector on the Opposite Wall

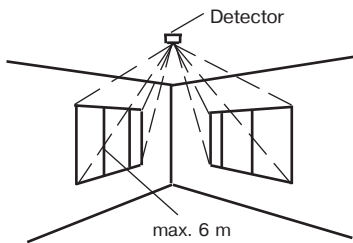

Figure 7 – Installing the Detector on the Ceiling (for window openings in the neighboring walls monitoring)

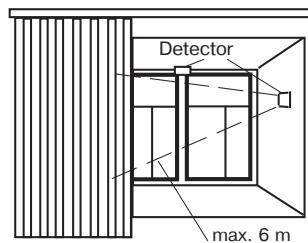

Figure 8 – Detector Installation between the Glass and the Curtains (Blinds) or on a Window Frame

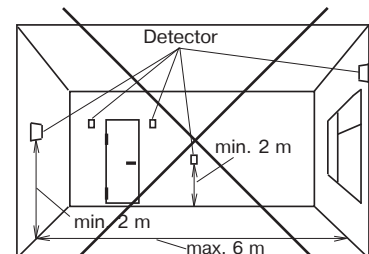

Figure 9 – Unauthorized Detector Installation Places

Made in Russia

«RIELTA» JSC, www.rielta.com

Chapaeva Str. 17, Saint Petersburg, Russia, 197101, rielta@rielta.com

Tel./fax: +7 (812) 233-0302, 703-1360,

Technical support, tel. +7 (812) 233-29-53, 703-13-57, support@rielta.ru

Rev.3 of 27.12.16
№ 00200