

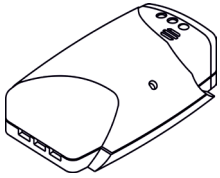

GLASS BREAK DETECTOR

«STEKLO-4»



Installation Guide

Introduction

- Glass break detector «Steklo-4» (hereinafter, the Detector):
- is intended for detecting destruction of all known kinds of construction glass: common, quenched, patterned, armored, multilayer and laminated with polymer film, glass units, as well as hollow glass blocks installed in structural units (openings) and/or interior elements of closed spaces;
 - generates alarm messages by control relay contacts opening and sends it to control panel (hereinafter, the CP);
 - ensures case tamper protection by «TAMPER» relay contacts opening;
 - may be installed on the wall or ceiling.

Features

- Ensures remote monitoring of controlled glazed structures in a closed area.
- Provides active acoustical protection against Detector masking by sound-proof item or fabric.
- Detects destruction of construction glass different kinds and shapes.
- Compatible with active ultrasonic and radio-wave detectors.
- Provides multilevel microprocessor signal processing, functional self-testing and regular monitoring of acoustic channel.
- Offers to use an opportunity to choose an algorithm of the Detector operation in accordance with situation on the secured object or with chosen security tactics.
- Displays modes of operation of the detector and noises inside the protected closed area by means of LED indication (providing possibility of noise and alarm indication disabling).
- Operates in temperature range from minus 20 up to + 45 °C, DC power supply range 9 ... 17 V.

Scope of delivery

Each Detector package contains the items listed in Table 1.

Table 1

Name	QNT
Glass break detector «Steklo-4»	1 pc.
Screw 3-3x30.016	2 pcs.
Glass break detector «Steklo-4». Installation Guide	1 copy

Field of Application

The Detector can be applied in offices, shops, museums, exhibition halls, banks, accommodation rooms, as well as in any types of objects with strict requirements to reliability of object protection (sabotage-immunity).

Installation

Before installing the Detector, get acquainted with the following requirements.

- When choosing the place of installation, the Detector detection zone location must be taken into account (Figure 1).
- It is recommended to install the Detector at a height not less than 2 m (see examples of installation in Figures 4 – 7).
- In order to exclude failures in active acoustic anti-masking channel operation, it is not allowed to install the Detector at the following places:
 - a) nearby conditioners or air flues;
 - b) on structures exposed to strong vibrations induced by nearby mechanisms and units operation;
 - c) in the places of possible shading of the Detector by opening door, window or vent sash wing, plant branches, curtain or louver, located at a distance closer 40 cm;
 - d) inside enclosed volume between window frames, with variable volume configuration (doors, ventilating windows or sash wings opening) during protection period.
- During joint operation with an active ultrasonic Detector, distance between Detectors must be not less than 1 m.
- Entire area of protected glass should be available to the Detector visibility zone.
- Microphone of the Detector should be directed to the protected glass structure.

- Distance (L) from the detector to the farthest point of protected area should not exceed 6 m.

Remove the cover of the Detector. Choose the place of the Detector installation and mark out it's fastenings using the Detector base for the purpose. Fasten the Detector with the help of screws.

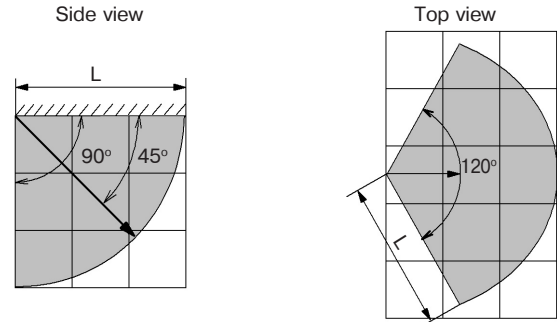

Figure 1 – Glass Break Detection Pattern

The Detector Connection

Fulfill the Detector connection in accordance with alarm loop (AL) connection pattern (Figure 2) or by separate alarm loops (Figure 3) to ensure alarm, tamper and masking messages transmission (A1 – Detector, A2 – single-loop CP, A3 – multi-loop CP, G1 – power supply unit, R1, R2 – CP terminal element).

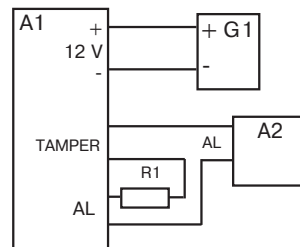

Figure 2

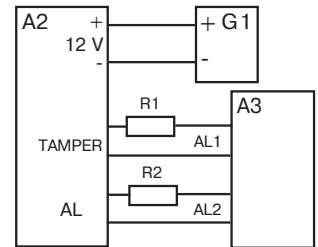

Figure 3

Setting up, Adjustment and Testing

Choose DIP-switches «1» – «4» position in accordance with the data listed in Table 2.

Table 2

DIP-switch position					Detector Operating Mode	
1	2	3	4	5		
OFF					Detection range adjustment in correspondence to the distance between Detector and secured glass	- less than 3 m
ON						- 3 ... 6 m
	OFF				Universal mode	Detection of glass destruction with chip fallout
		OFF			Alarm memory indication	- OFF - ON
			OFF		Control of interference and alarm LED indication	- OFF - ON
				OFF	Standby mode	Automatically switches OFF in 15 min
				ON	Testing mode	

In order to fulfill sensitivity testing within pre-installed detection range (by DIP-switch «1»), act as follows:

- energize the Detector;
- turn the Detector to testing mode by means of DIP-switch «5»;
- Suspend a steel ball 20 – 22 mm in diameter on a 30 ... 35 cm long thread, press free end of it to the upper side of a glass structure (ordinary, ornamental, armed, laminated), deflect it at an angle of (45 ± 15)° (chosen in dependence of a type, strength or thickness of a glass). Deliver a blow, whereupon the Detector should generate an alarm message;
- switch off DIP-switch «5», close the cover. Assure oneself of the Detector masking objects absence;
- switch off power supply and subsequently energize the Detector. The Detector is ready for operation.

Notes:

1 Message about masking is generated not later than 2 min after microphone opening sealing by sound-proof fabric.

2 The Detector turns to standby mode automatically in 15 min after DIP-switch «5» turning on.

Installation Examples

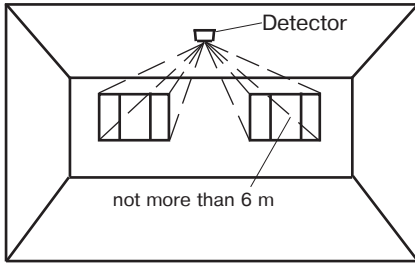

Figure 4 – Ceiling mounting (for monitoring of window openings in nearby walls)

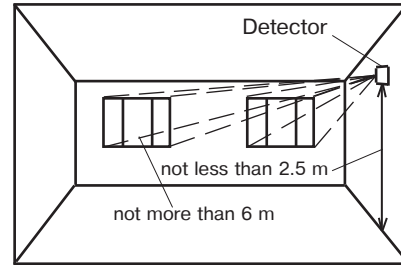

Figure 5 – Mounting on the Side Wall

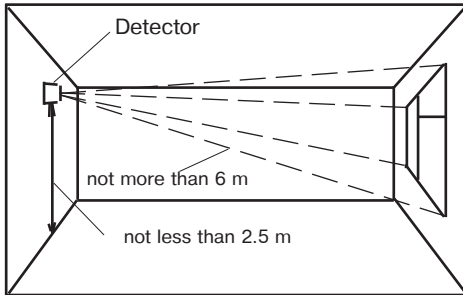

Figure 6 – Mounting on the Opposite Wall

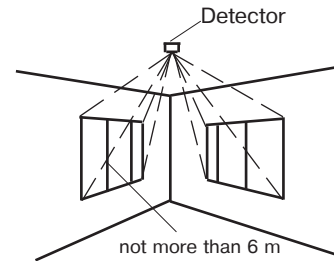

Figure 7 – Installing the Detector on the Ceiling (for window openings in the neighboring walls monitoring)

Packing Certificate

Glass break detector «Steklo-4» has been manufactured in compliance with the active technical documentation, classified as fit for operation and packed by «RIELTA» JSC.

Packing date _____
month, year